

HFA 700CII SPECIFICATIONS

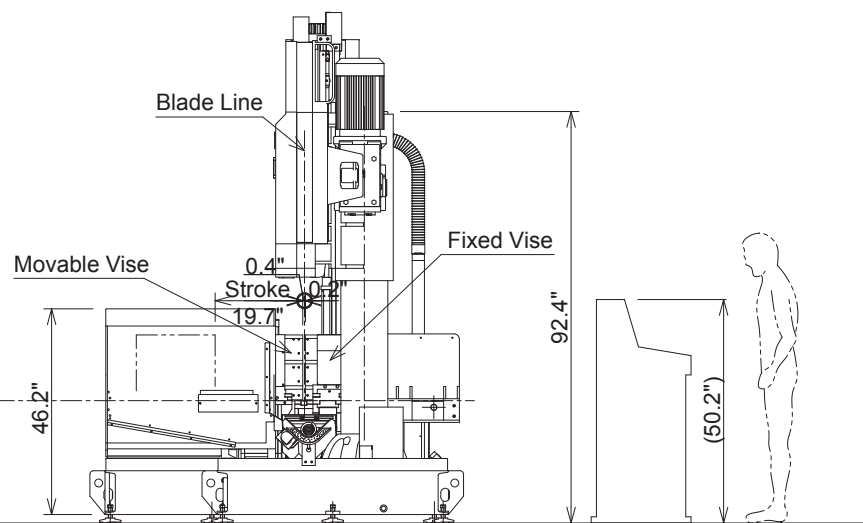

* Specifications may change without notice at the sole discretion of Amada's Engineering Department.